

MHHS-DEL2431 - [04a] Migration Business Process Models

Document Control			
Version	Description	Author	Date
0.1	Draft for Industry Consultation	Migration Team	18/03/2024
0.2	Revised Draft for Assurance Meeting	Migration Team	19/04/2024
1.0	Version Uplifted following MCAG Interim Approval	Migration Team	08/05/2024

Cover Note

This document displays the proposed target state from the Migration Control Centre.

See MHHS-DEL2430 - [04] Migration Requirements and Processes for the descriptions of the processes in this document.

It shows interactions between industry participants, and it's purpose is to provide context and understand the Events and triggers that will control and govern the creation of the migration schedule,

NOTE:

- **Processes outside of the MCC are indicative representations ONLY.**
- **They are intended as a low-fidelity reference to show the essence of those process**
- **As a result facilitate, and elicit understanding in order to refine and develop further the MCC processes and requirements.**

It begins with the one off Activities related to the creation of the first schedule prior to M10.

- 01 Define and Design and Consult
- 02 Initialize Schedule
- 03 Maintain Schedule







The Manage Migration processes are and continue during the entire Live Migration Window.







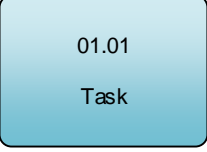
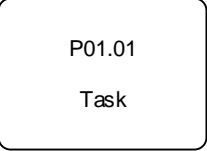

- 03 Maintain Schedule
- 04 Control and Monitor
- 05 Manage Daily Dynamic Capacity Allocation
- 06 Data Analytics and Reporting

The process ends with the close down and clean-up activities related to the MCC.

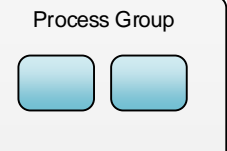
- 07 Close Down Migration

MHHS Migration – Business Process Modelling Notation (BPMN) Key

	Start Event		Intermediate Event		End Event
			Process Link		
			Message Event		
			Multiple Triggers		
			Signal		

	Task: This represents a specific action or step in the process
	Indicative Task: Indicative activity to aid understanding and representative only
	Sub-Process: A collapsed process comprised of a series of other tasks/processes
	Process Group: An collapsed view of tasks and/or sub-processes
	Exclusive (XOR) Gateway: Decision to go one way or another
	Parallel (AND) Gateway: Initiate multiple steps
	Inclusive (OR) Gateway: Offers multiple paths but more flexible than the XOR
	Message Flow
	Sequence Flow
	Data Object

BPM for MCC and Migration Schedule

BPM - Level 0

VERSION:

0.1

AUTHOR:

28/02/2024 by Alf Chivers

VERSION AUTHOR:

18/03/2024 by Author

MHHS

Level 0

Business Process Model for MCC and Migration Schedule

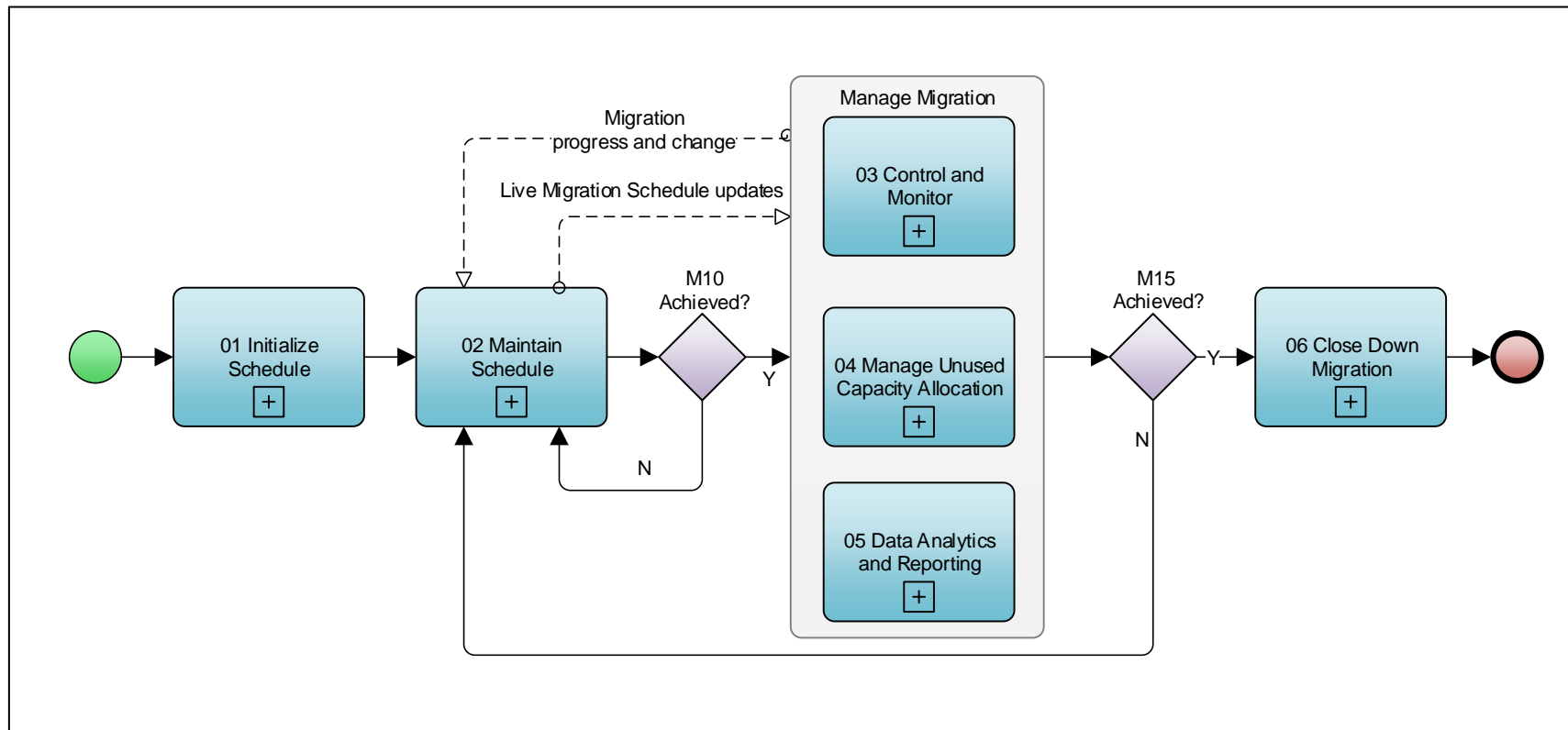

01. Initialise Schedule

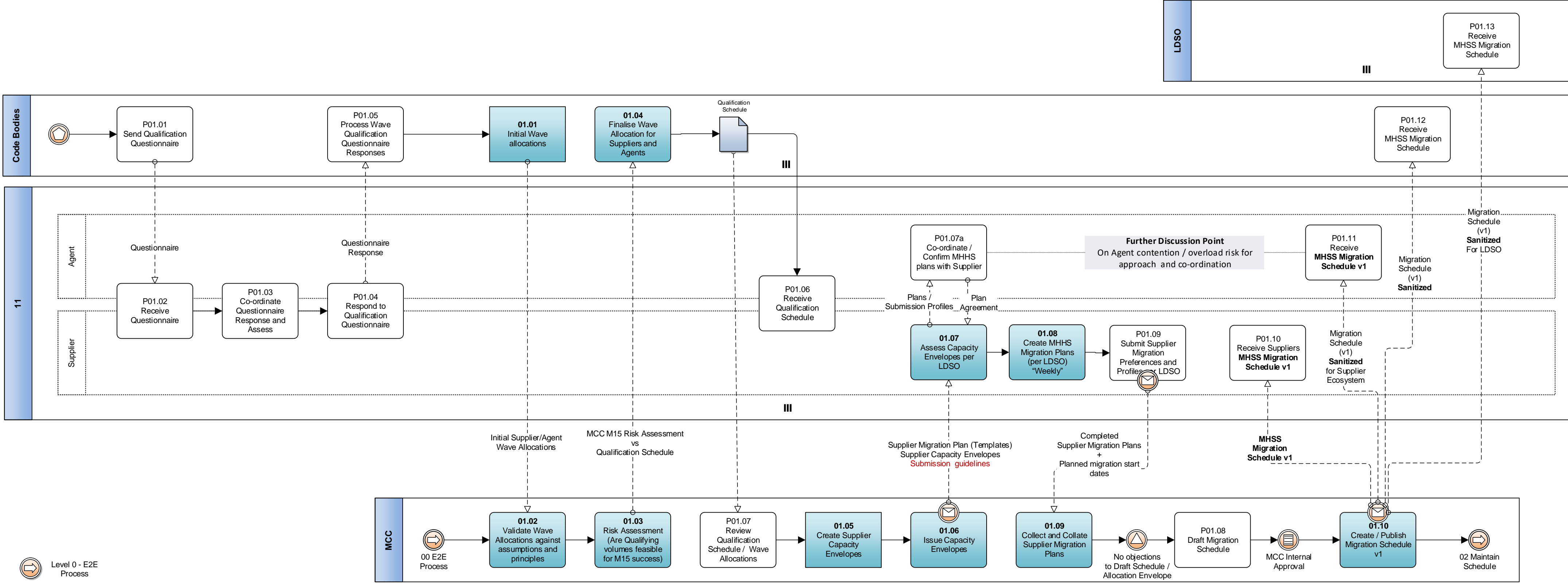

Level 0 - E2E Process

O2 Maintain Schedule

BPM - Level 1

VERSION:

0.2

AUTHOR:

26/02/2024 by AI/CHvers

VERSION AUTHOR:

19/04/2024 by Author

Level 0 - E2E Process

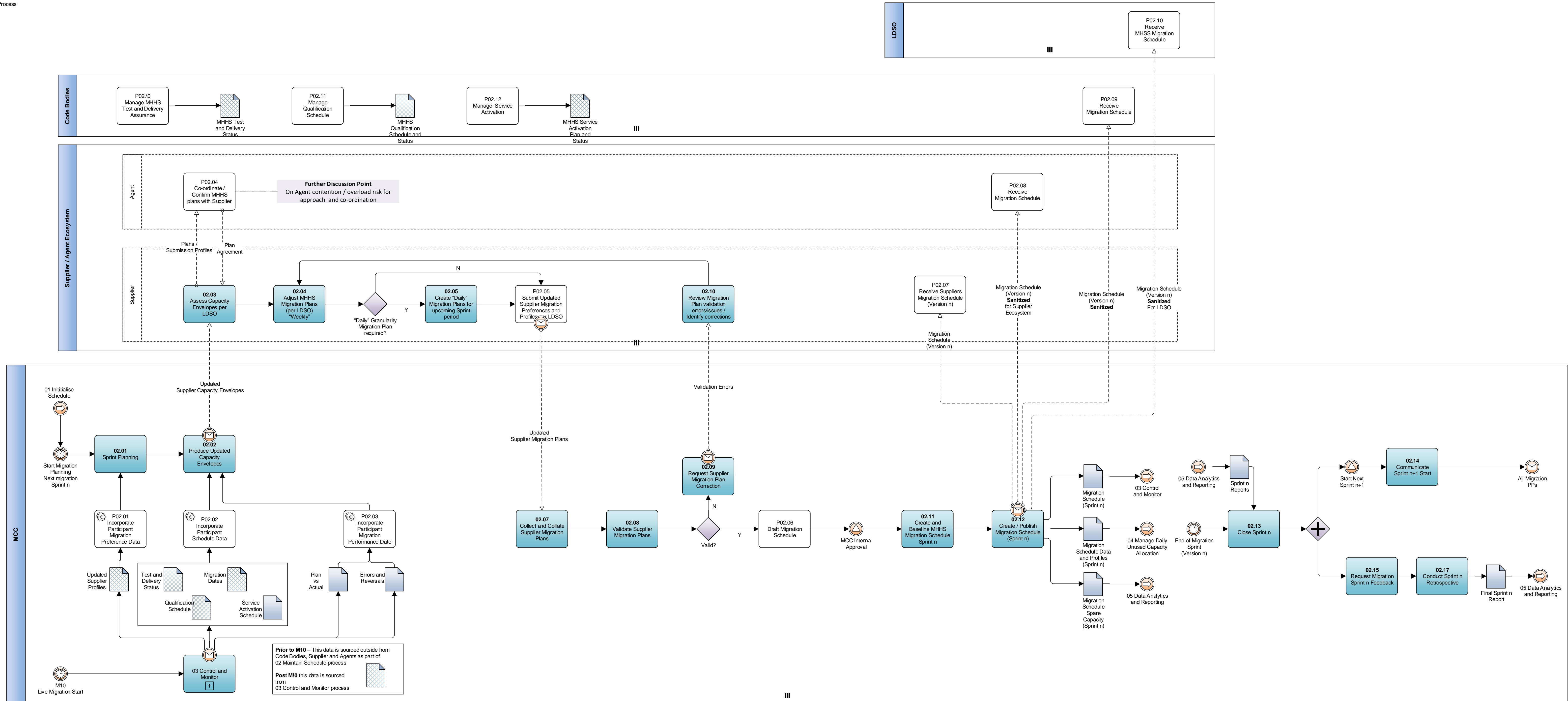

03 Control and Monitor

BPM - Level 1

VERSION:

0.1

AUTHOR:

26/02/2024 by Alf Chivers

VERSION AUTHOR:

27/02/2024 by Author



Level 0 - E2E
Process

To be included in future consultations

04 Manage Unused Capacity Allocation

BPM - Level 1

VERSION:

0.1

AUTHOR:

26/02/2024 by Alf Chivers

VERSION AUTHOR:

27/02/2024 by Author



Level 0 - E2E
Process

To be included in future consultations

05 Data Analytics and Reporting

BPM - Level 1

VERSION:

0.1

AUTHOR:

26/02/2024 by Alf Chivers

VERSION AUTHOR:

27/02/2024 by Author



Level 0 - E2E
Process

To be included in future consultations

06 Close Down Migration

LEVEL 1: BPMN

VERSION:

0.1

AUTHOR:

26/02/2024 by Alf Chivers

VERSION AUTHOR:

27/02/2024 by Author



Level 0 - E2E
Process

To be included in future consultations